

**Semi Automatic Divider Rounder**

MODEL: DSA336



Shown in Standard Epoxy Coat & Stainless Steel

**FEATURES & BENEFITS**

- 36 Portion Cutting Head with (3) Sanitary Rounding Plates
- Recommended for Dough Absorption Ratio: 55 - 65%
- Lubrication Free Shafts
- Belt Driven Transmission
- Heavy Duty Low Profile Casters for Mobility
- Feet in AISI304 Stainless Steel - prevents rusting
- Knives in AISI304 Stainless Steel
- Easy to clean & maintain - no tools required
- Interchangeable Head Piece (Requires Additional Head—Sold Separately)
- Adjustable Portion Size between 0.8 oz to 3 oz (25 - 80 grams)

**OPTIONS & ACCESSORIES**

- Stainless Steel Construction (Suffix I)
- Additional Dough Plates (EA)
- 15 Portion Divider Head with Plates (DSAH15)
- 30 Portion Divider Head with Plates (DSAH22)
- 30 Portion Divider Head with Plates (DSAH30)
- 54 Portion Divider Head with Plates (DSAH54)
- International Electrical Configuration (208-240V)

**STANDARD PRODUCT WARRANTY**

One Year Labor & Two Year Parts

**FINISH**

Epoxy Painted Galvanized Carbon Steel

**DIMENSIONS & SHIPPING WEIGHT**

24 7/16" W X 26" D X 52 3/8" H  
(621 mm X 660 mm X 1330 mm)  
850lb (386 kg)

**ELECTRICAL SYSTEM**

1 Phase (Ground Wire not Included):

- 120 V - 8 A - 0.96 kW - 60 Hz - Nema 5-15P
- 208 V - 4.6 A - 0.96 kW - 50/60 Hz - 2 Wires + Ground
- 240 V - 4 A - 0.96 kW - 50/60 Hz - 2 Wires + Ground

**DRAWINGS**

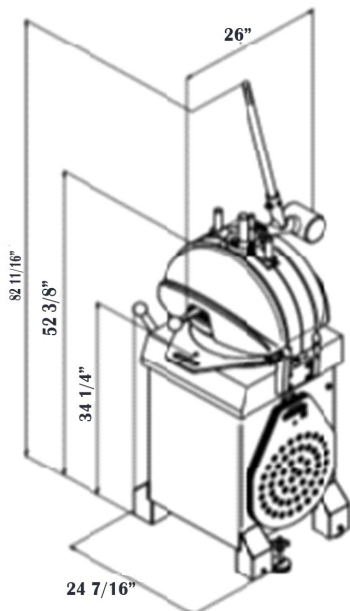

**SHORT SPECIFICATION**

Divider Rounder, Semi Automatic, Electric, Epoxy Painted Galvanized Carbon Steel Frame, 36 Portion Dividing Head with Plates, Belt Driven Transmission, Interchangeable Head, One Year Labor & Two Year Parts Warranty