



Project _____

Item # _____

Quantity _____

Rapide Cuisine® Drop-In High-Powered/Heavy-Duty Dual Induction Ranges

Models: IRNG-PB2-16, -18, -29, -36, -24-IA, -36-IA

Hatco's patent-pending Rapide Cuisine® High-Powered/Heavy-Duty Drop-In Dual Induction Ranges offer industry-leading features and true back-of-house power in a commercial kitchen proof package. These are dual units that are configured either front-to-back or side-to-side to optimize your countertop footprint.

The unit features optimization systems like Magnetic Power System (MPS) to deliver the highest power in its class; safety features like Pan Sense Technology (PST), which means the unit only activates when a pan is present; and convenience features like User Programmable Presets (UPP), where up to six menu items using three stages of cooking can be programmed and saved - great for repeat menu items. Or choose a power level and a doneness temperature target when using either of both of the probe(s).

More powerful options to suit available power units. The industry leading "IA" models feature Optimal Power Control (OPC) which delivers higher power from lower amperage circuits, boosting power by 25% when needed, and allowing for a double unit on what would normally be a single unit circuit. Allows a double unit to occupy the same linear footprint as a single unit, hence doubling production while remaining within UL standard.

Standard features:

- Food temperature probes for more accurate cooking
- Timers (up to 10 hours, more if in program mode)
- High resolution color displays
- Power (0-100) or temperature (°F or °C modes)
- Heavy gauge stainless steel housing with side impact protection for the top
- Eight surface temperature sensors
- Culinary equivalent of up to 31,000 BTUs gas per burner
- Grease filters
- Highest ambient tolerance on the market 124 °F (51°C)- it's tough
- Numerous options to suit available power circuits, including the unique "IA" models that deliver the highest available power from lower amperage circuits
- USB ports for downloading updates

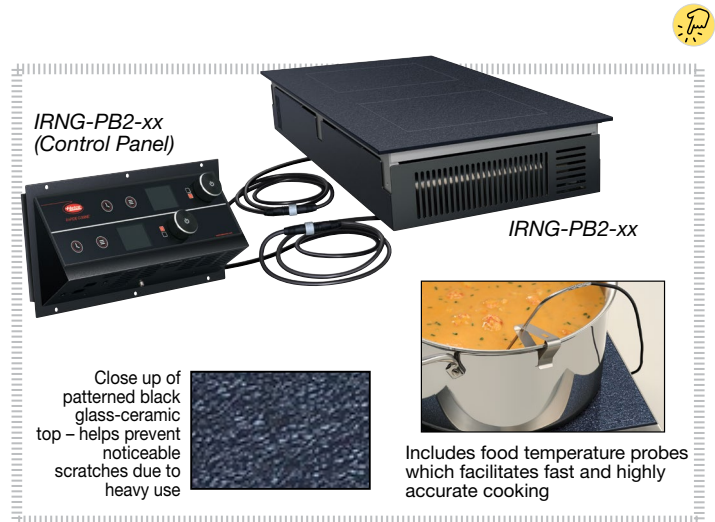

Accessory (available for purchase at any time)

- Trim Ring* in Stainless Steel (holds unit nearly flush on a stainless steel counter (TRIM-PB2-SS))

*For use where chair-step routing of the countertop material is not possible, but a flush-mounted look is desired.

For operation, location and safety information, please refer to the Installation and Operating Manual.



HATCO CORPORATION | P.O. Box 340500 Milwaukee, WI 53234-0500 U.S.A. | (800) 558-0607 | (414) 671-6350



www.hatcocorp.com | support@hatcocorp.com | [Find a Hatco Rep](#) | [Image Library](#) | [Document Library](#) | [Chat](#)



Rapide Cuisine® Drop-In High-Powered/ Heavy-Duty Dual Induction Ranges

Models: IRNG-PB2-16, -18, -29, -36, -24-IA, -36-IA

IRNG-PB2-xx Models

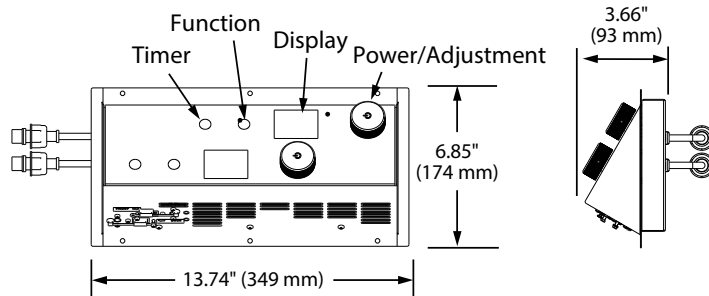
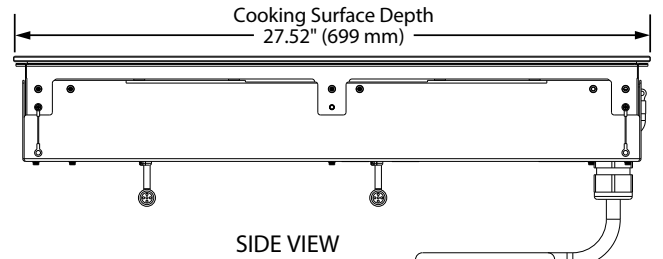
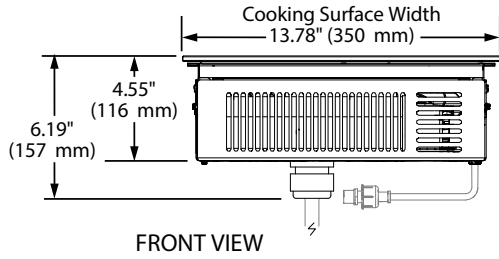

Cutout Dimensions for Control Panel

Model	Width	Height
IRNG-PB2-16, -18, -29, -36, -24-IA, -36-IA	12.99" (330 mm)	5.9" (150 mm)

Model Cutout Dimensions for Flush Mount for IRNG-PB2-xx

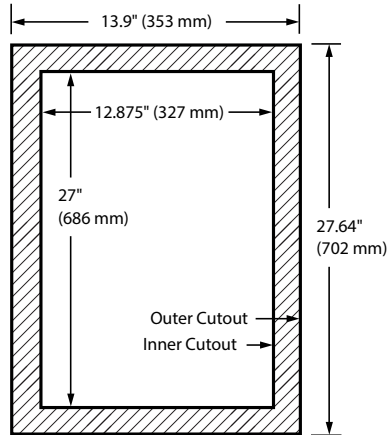

Cutout Dimensions for Flush Mount

Model	Outer Cutout		Inner Cutout	
	Width	Depth	Width	Depth
IRNG-PB2-16, -18, -29, -36, -24-IA, -36-IA	13.9" (353 mm)	27.64" (702 mm)	12.875" (327 mm)	27" (686 mm)

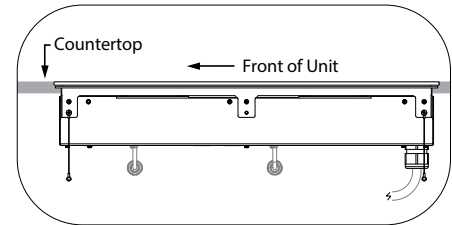
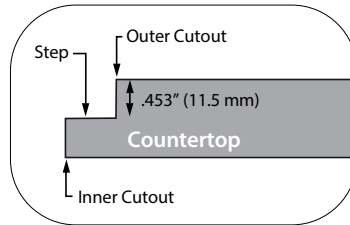

Cutout Dimensions for Trim Ring for IRNG-PB2-xx

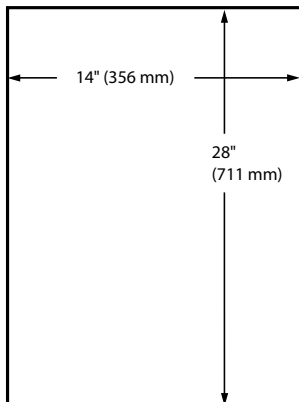

Cutout Dimensions for Trim Ring

Model	Width	Depth
IRNG-PB2-xx	14" (356 mm)	28" (711 mm)

Cutaway view of Trim Ring

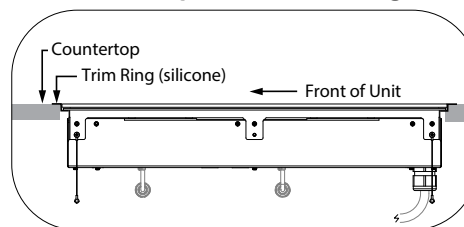

HATCO CORPORATION | P.O. Box 340500 Milwaukee, WI 53234-0500 U.S.A. | (800) 558-0607 | (414) 671-6350



www.hatcocorp.com | support@hatcocorp.com | [Find a Hatco Rep](#) | [Image Library](#) | [Document Library](#) | [Chat](#)



Rapide Cuisine® Drop-In High-Powered/ Heavy-Duty Dual Induction Ranges

Models: IRNG-PB2-16, -18, -29, -36, -24-IA, -36-IA

IRNG-PB2-xx Model Ventilation Requirements

Cabinets should be sufficiently open to allow fresh air to cool the units. Two areas 40 sq. inches (1016 sq. mm) each should be provided for each unit. These should be located as close as possible to the intake (front) and exhaust (rear) sides of the unit. In cases where the cabinet is located against wall, install one opening near the control panel and the other toward the bottom of the cabinet.

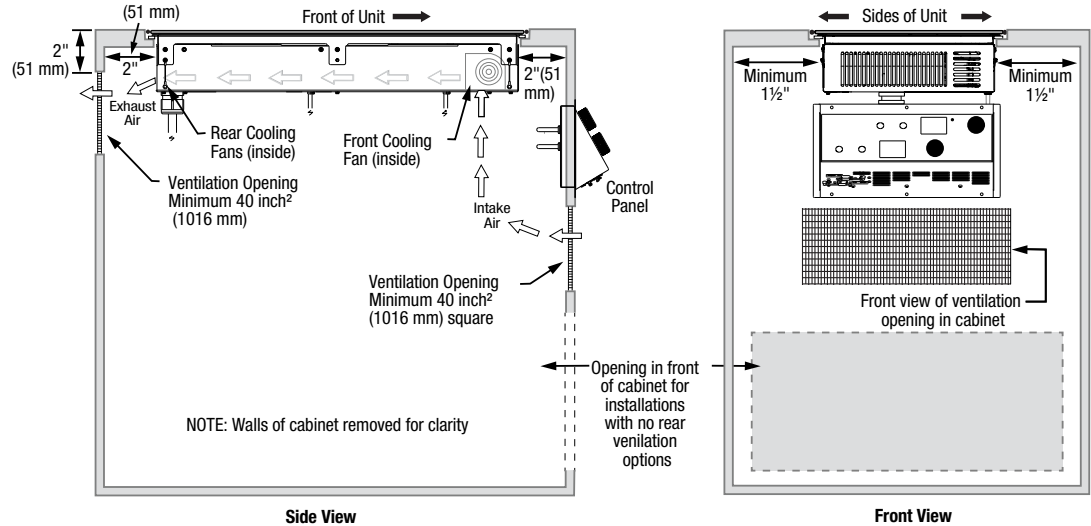

SPECIFICATIONS High-Powered/Heavy-Duty Drop-In Dual Induction Ranges

The shaded areas contain electrical information for International models only

Model	Dimensions (W x D x H)	Volts	Watts (Per Hob)	Amps	Total Power (Watts)	HZ	Plug	Cord Location	Ship Weight*
IRNG-PB2-24-IA	13.78" x 27.52" x 6.19" (350 x 699 x 157 mm)	208	1803	20	3606	60	NEMA 6-20P	Rear left bottom base corner	41 lbs. (19 kg)
		240	2400		4800				
IRNG-PB2-36-IA		208	3120	30	6240		NEMA 6-30P		
		240	3600		7200				
IRNG-PB2-29		208	2496	24	4992		NEMA 6-30P		
		240	2880		5760				
IRNG-PB2-36		208	3120	30	6240	NEMA 6-50P			
		240	3600		7200				
IRNG-PB2-36		220/230/240 (CE)	3300/3450/3600	30	6600/6900/7200	50-60	IEC-309		
		220/60	3300		6600	60			
IRNG-PB2-16	220/230/240 (CE)	1430/1495/1560	13	2860/ 2990/3120	50-60	BS-1363			
	220/60	1430		2860	60				
IRNG-PB2-18	220/230/240 (CE)	1650/1725/1800	16	3300/3450/3600	50-60	CEE 7/7 SCHUKO, CCC			
			15			AU			

* Shipping weight includes packaging and is approximate.

PAN SIZE

Maximum Pan Size: 14" diameter (356 mm), Minimum Pan Size: 4" diameter (102 mm).





Rapide Cuisine® Drop-In High-Powered/ Heavy-Duty Dual Induction Ranges

Models: IRNG-PB2-16, -18, -29, -36, -24-IA, -36-IA

PLUG CONFIGURATIONS

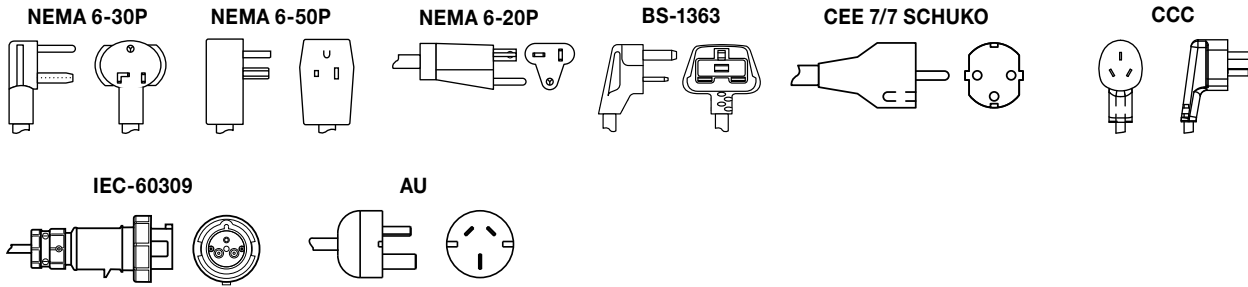

PRODUCT SPECS Rapide Cuisine® Drop-In High-Powered/ Heavy-Duty Dual Induction Ranges

The High-Powered/Heavy-Duty Drop-In Dual Induction Range shall be a Rapide Cuisine® model, manufactured by the Hatco Corporation, Milwaukee, WI 53234 U.S.A.

The Induction Range shall be rated at ... watts, ... volts, single phase and be ... inches (millimeters) in overall width. The Drop-In Dual Induction Range shall consist of a stainless steel housing with an aluminum base with a glass-ceramic top with two induction generators and two power coils. It shall include a remote control box with a glass touch panel, a color-coordinated control (CCC) for 0-100% power levels and

temperature control in F° or C°. The range will be controlled via a digital encoder and feature a USB port (for updates and future access to additional operating modes) and two 27.5" (700 mm) cables. The remote control box is connected to the main case with a quick disconnect connector. Food temperature probes and 71" (1800 mm) cord and plug is included.

Warranty consists of 24/7 parts and service assistance (US and Canada only).

HATCO CORPORATION | P.O. Box 340500 Milwaukee, WI 53234-0500 U.S.A. | (800) 558-0607 | (414) 671-6350



www.hatcocorp.com | support@hatcocorp.com | [Find a Hatco Rep](#) | [Image Library](#) | [Document Library](#) | [Chat](#)